

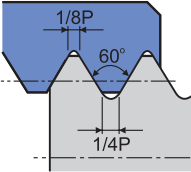

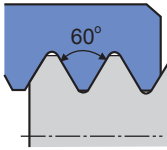

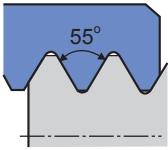



Turning

THREADING TOOLS

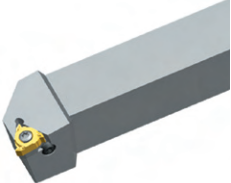
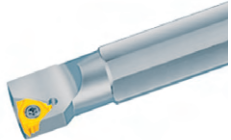

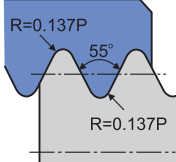
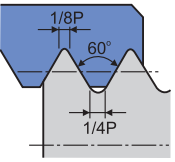
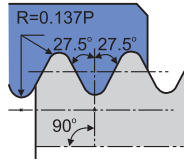
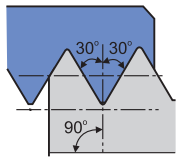
Threading tools overview	P146-151
Code key for threading inserts	P153
ISO metric threading insert	P154-155
General pitch threading insert without end	P156
Whitworth thread insert	P157
Unified thread insert with a shoulder	P158
British standard taper pipe thread insert	P159
NPT American standard taper pipe thread	P160
UNJ American standard aerospace and aviation threads	P161
American ACME	P162
American STUB-ACME (Short tooth threads)	P163
API 60°	P164
API Round	P165
API Buttress casing	P166
ISO metric threading insert (Thin type)	P167-168
General pitch threading insert without end (Thin type)	P169
Whitworth thread insert (Thin type)	P170
Unified thread insert with a shoulder (Thin type)	P171
British standard taper pipe thread insert (Thin type)	P172
NPT American standard taper pipe thread insert (Thin type)	P173
External threading tools code key	P174
Internal threading tools code key	P175
External threading tools	P176-178
Internal threading tools	P177-178
Recommended cutting parameters list	P181
Common problem in threading and solutions	P183



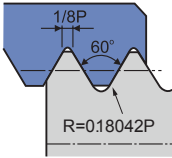
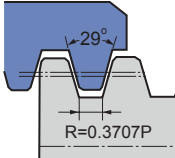

● Threading tools overview

Applications		For general			
Cutline					
Thread name		ISO metric thread With end	General pitch thread Without end	General pitch thread Without end	
Profile		GM	60	55	
Shape of insert (length: 0.43, 0.63, 0.87inch)		As picture shows R type external threads  P154	As picture shows R type external threads  P156	As picture shows R type external threads  P156	
Tool holder	Pitch	Dimensions (inch) (H×W×L) (Dia×L×Min. dia)	Pitch/Inch	Pitch/inch(teeth/Inch)	Pitch/inch(teeth/Inch)
	External thread  P176	.625 x .625 x 4 .750 x .750 x 5 1.00 x 1.00 x 6 1.25 x 1.35 x 7	0.039~0.236	0.02~0.197 (5~48)	0.02~0.197(5~48)
Internal thread  P177	.625 x 6 x .630 .750 x 7 x 1.00 1.00 x 6 x 1.25 1.25 x 8 x 1.50 1.5 x 12 x 2.00 2.00 x 14 x 2.50	0.039~0.236	0.02~0.197 (5~48)	0.02~0.197 (5~48)	

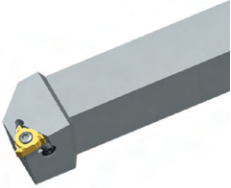
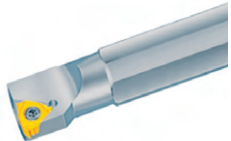
Applications		For general	For aerospace and aviation industries	Pipe thread for heater, gas and water	For connecting between pipe fitting and coupling of gas and water
Cutline					
Thread name		Whitworth thread	Unified thread (American standard threads)	British standard taper pipe threads	American standard taper pipe threads
Profile		W	UN	BSPT	NPT
Shape of insert (length: 0.43, 0.63, 0.87 inch)		As picture shows R type external threads  P157	As picture shows R type external threads  P158	As picture shows R type external threads  P159	As picture shows R type external threads  P160
Dimensions (inch) (H×W×L) (Dia×L×Min. dia)		Teeth/Inch	Teeth/Inch	Teeth/Inch	Teeth/Inch
External thread	.625 x .625 x 4 .750 x .750 x 5 1.00 x 1.00 x 6 1.25 x 1.35 x 7	8~16	8~20	11~28	8~27
	.625 x 6 x .630 .750 x 7 x 1.00 1.00 x 6 x 1.25 1.25 x 8 x 1.50 1.5 x 12 x 2.00 2.00 x 14 x 2.50	8~16	8~20	11~28	8~27

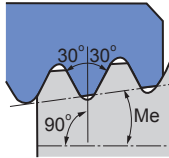
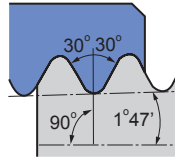
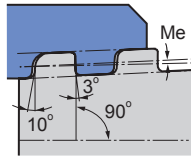

Applications		For aerospace and aviation industries	Trapezoidal screw mandrel for transmission		
Cutline					
Thread name		UNJ (American standard aerospace and aviation threads)	American ACME	Short tooth threads	
Profile		60	ACME	STUB —ACME	
Shape of insert (length: 0.43, 0.63, 0.87inch)		As picture shows R type external threads  P161	As picture shows R type external threads  P162	As picture shows R type external threads  P163	
Tool holder	Pitch	Dimensions (inch) (H×W×L) (Dia×L×Min. dia)	Teeth/Inch	Teeth/Inch	Teeth/Inch
	External thread  P176	.625 x .625 x 4 .750 x .750 x 5 1.00 x 1.00 x 6 1.25 x 1.35 x 7	8 ~32	8~16	8~16
Internal thread  P177	.625 x 6 x .630 .750 x 7 x 1.00 1.00 x 6 x 1.25 1.25 x 8 x 1.50 1.5 x 12 x 2.00 2.00 x 14 x 2.50	--	8~16	8~16	

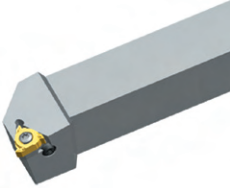
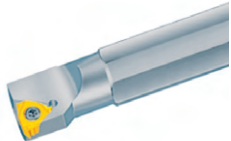
Applications		Petroleum and gas pipeline			
Cutline					
Thread name		API (60°)	API(Round)	API(Buttress casing)	
Profile		60	API	API	
Shape of insert (length: 0.43, 0.63, 0.87inch)		As picture shows R type external threads  P164	As picture shows R type external threads  P165	As picture shows R type external threads  P166	
Tool holder	Pitch	Dimensions (inch) (H×W×L) (Dia×L×Min. dia)	Teeth/Inch	Teeth/Inch	Teeth/Inch
	External thread  P176	.625 x .625 x 4 .750 x .750 x 5 1.00 x 1.00 x 6 1.25 x 1.35 x 7	4~5	8~10	5
Internal thread  P177	.625 x 6 x .630 .750 x 7 x 1.00 1.00 x 6 x 1.25 1.25 x 8 x 1.50 1.5 x 12 x 2.00 2.00 x 14 x 2.50	4~5	8~10	5	

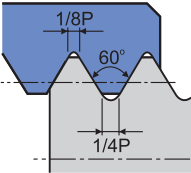
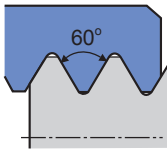
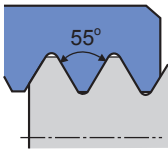
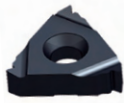
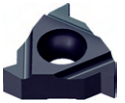
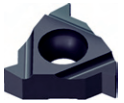
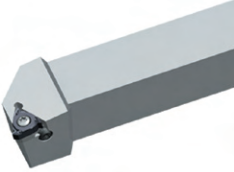
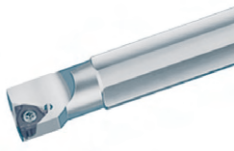

Applications		For general			
Cutline					
Thread name		ISO metric thread With end (Thin type)	General pitch thread Without end (Thin type)	General pitch thread Without end (Thin type)	
Profile		GM	60	55	
Shape of insert (length: 0.43, 0.63, 0.87inch)		As picture shows R type external threads  P167	As picture shows R type external threads  P169	As picture shows R type external threads  P169	
Tool holder	Pitch	Dimensions (inch) (H×W×L) (Dia×L×Min. dia)	Pitch/Inch	Pitch/inch(teeth/Inch)	Pitch/inch(teeth/Inch)
	External thread  P178	.625 x .625 x 4 .750 x .750 x 5 1.00 x 1.00 x 6 1.25 x 1.35 x 7	0.019~0.118	0.019~0.118(8~48)	0.019~0.118(8~48)
Internal thread  P178	.625 x 6 x .630 .750 x 7 x 1.00 1.00 x 6 x 1.25 1.25 x 8 x 1.50 1.5 x 12 x 2.00 2.00 x 14 x 2.50	0.019~0.118	0.019~0.118(8~48)	0.019~0.118(8~48)	



Applications		For general	For aerospace and aviation industries	Pipe thread for heater, gas and water	For connecting between pipe fitting and coupling of gas and water	
Cutline						
Thread name		Whitworth thread (Thin type)	Unified thread (American standard threads, Thin type)	British standard taper pipe threads (Thin type)	American standard taper pipe threads (Thin type)	
Profile		W	UN	BSPT	NPT	
Shape of insert (length: 0.43, 0.63, 0.87inch)		As picture shows R type external threads 	As picture shows R type external threads 	As picture shows R type external threads 	As picture shows R type external threads 	
Tool holder	Pitch	Teeth/Inch	Teeth/Inch	Teeth/Inch	Teeth/Inch	
	Dimensions (inch) (H×W×L) (Dia×L×Min. dia)					
External thread	 P178	.625 x .625 x 4 .750 x .750 x 5 1.00 x 1.00 x 6 1.25 x 1.35 x 7	8~16	8~20	11~28	8~27
Internal thread	 P178	.625 x 6 x .630 .750 x 7 x 1.00 1.00 x 6 x 1.25 1.25 x 8 x 1.50 1.5 x 12 x 2.00 2.00 x 14 x 2.50	8~16	8~24	11~28	8~27

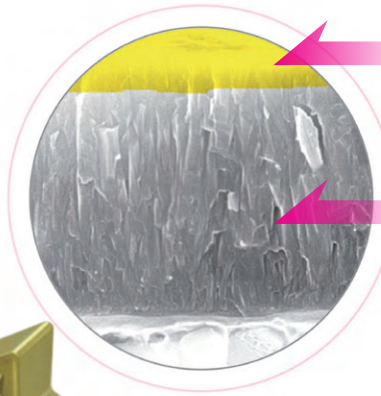
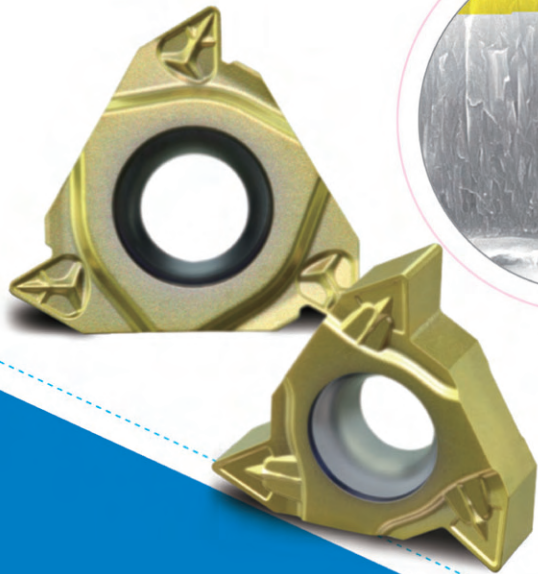

Gold TiN coating reduces friction between cutting edge and workpiece and allows observation of flank wear.

The inner layer nc-TiAlN coating has outstanding wear resistance.

Threading Grade YBG201 is upgraded to be nc-TiAlN

YBG201

PVD coating alloy has good toughness and wear resistance, it's the unique threading grade for machining of carbon steel, stainless steel and cast iron etc.

The function and application of full form threading

Reduce machining procedures

Not necessary to finish machine workpiece prior to threading. Full form insert tops the thread on the last pass and thereby finishes the thread and thread form. No burrs remain and the surface quality is good.

Automatically remove burrs

The wiper on threading insert finishes major diameter of machined surface, eliminating need for burr removal after machining.

Chipbreaker in Threading insert

Outstanding chip breaking performance

Wavy chipbreaker is built into rake face of threading insert. Chips are directed up and away from cutting edge and workpiece to enhance surface finish and overall efficiency.

Good general purpose chipbreaker

Due to the chipbreaker design, which controls and manages the formation of the chip, different workpiece materials can be threaded successfully.

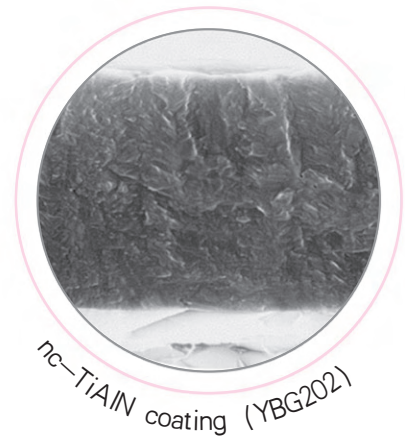

nc-TiAlN coating (YBG202)

High-performance nanostructure coating guarantees good toughness and hardness of inserts. Special coating technology guarantees smooth surface and excellent wear resistance. Outstanding thermal stability and chemical stability effectively protect cutting edge.

YBG202

nc-TiAlN coating and ultra-fine grain substrate makes it suitable for finishing and semi-finishing of various materials and turning of super alloy.



Code key for threading inserts

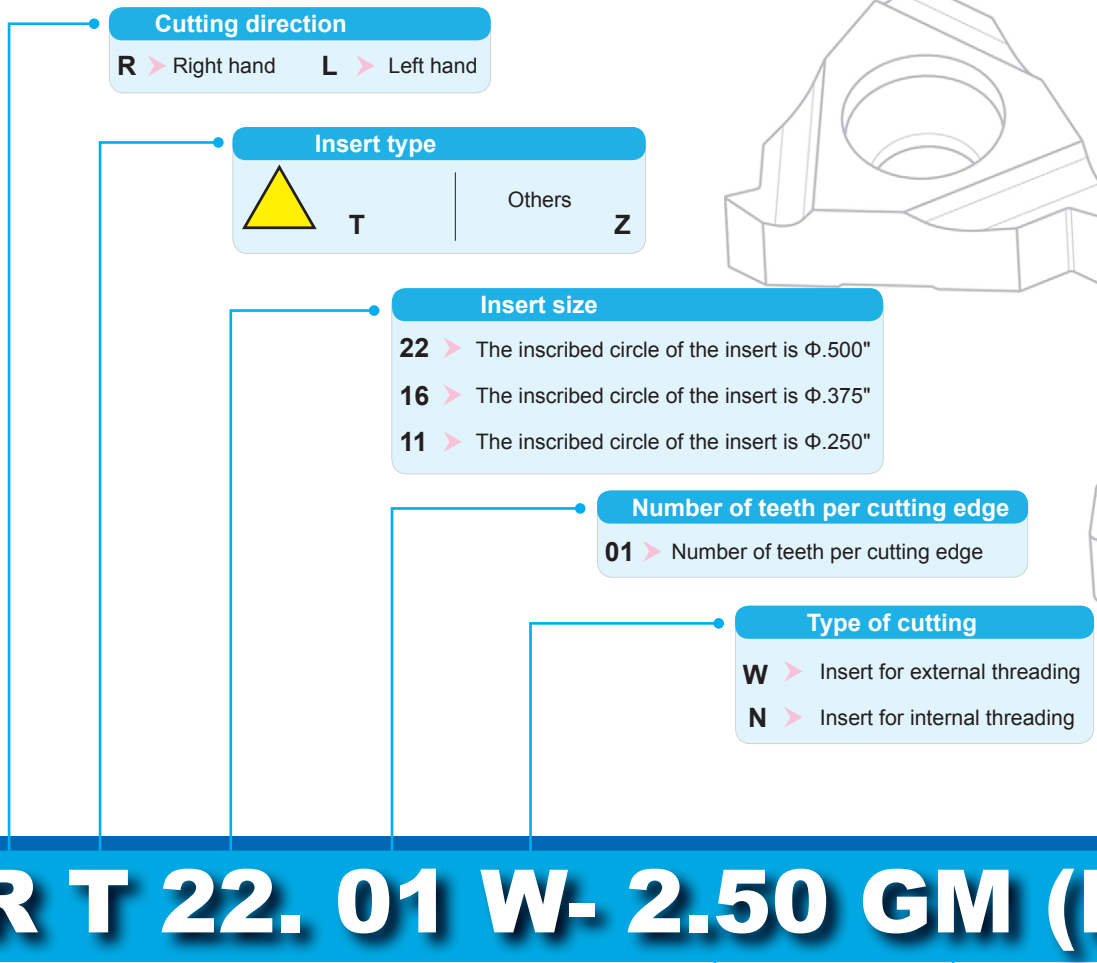

R T 22. 01 W- 2.50 GM (P)

Pitch width

Omni-tooth(Range of pitch indicated in numerals)

inch	TPI
0.014-0.354	72-2

V-tooth(Range of pitch indicated in letters)

	A	AG	G	N	Q
inch	0.019-0.059	0.019-0.118	0.069-0.118	0.138-0.197	0.217-0.236
TPI	48-16	48-8	14-8	7-5	41/2-4

Thread profile

GM	60°ISO metric threads
60	60°general pitch threads
55	55°general pitch threads
W	Whitworth threads
UN	Unified threads(American standard)
BSPT	British standard taper pipe threads
NPT	American standard taper pipe threads
UNJ	American standard aerospace and aviation threads
AC	American ACME
AP	API 60°
RD	API Round

Chip-breakers are indicated by P

(P is omitted when it is metric thread)

ISO metric threading insert

ISO 965-1980 DIN 13
 GB/T 197-2003 Tolerance class: 6g/6H

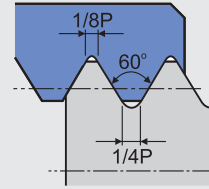

External threading

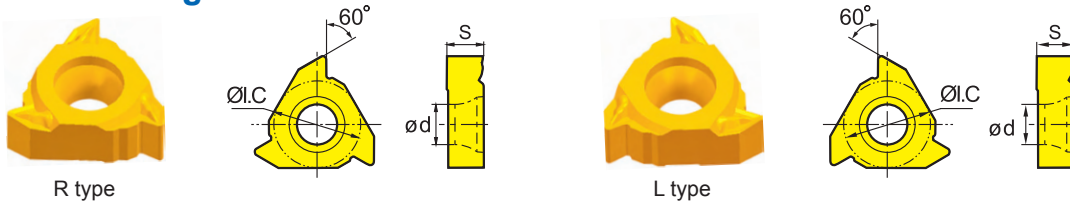

Type		Dimension(inch)				Grade	
						Coated	Uncoated
Right hand type	Left hand type	Pitch width (inch)	S	ØI.C	Ød	YBG201	YD201
RT16.01W-1.00GM	LT16.01W-1.00GM	0.039	0.156	0.375	0.173	○	
RT16.01W-1.25GM	LT16.01W-1.25GM	0.049	0.156	0.375	0.173	○	
RT16.01W-1.50GM	LT16.01W-1.50GM	0.059	0.156	0.375	0.173	○	
RT16.01W-1.75GM	LT16.01W-1.75GM	0.069	0.156	0.375	0.173	○	
RT16.01W-2.00GM	LT16.01W-2.00GM	0.079	0.156	0.375	0.173	○	
RT16.01W-2.50GM	LT16.01W-2.50GM	0.098	0.156	0.375	0.173	○	
RT16.01W-3.00GM	LT16.01W-3.00GM	0.118	0.156	0.375	0.173	○	
RT22.01W-3.50GM	LT22.01W-3.50GM	0.138	0.217	0.500	0.217	○	
RT22.01W-4.00GM	LT22.01W-4.00GM	0.157	0.217	0.500	0.217	○	
RT22.01W-4.50GM	LT22.01W-4.50GM	0.177	0.217	0.500	0.217	○	
RT22.01W-5.00GM	LT22.01W-5.00GM	0.197	0.217	0.500	0.217	○	
RT22.01W-5.50GM	LT22.01W-5.50GM	0.217	0.217	0.500	0.217	○	
RT22.01W-6.00GM	LT22.01W-6.00GM	0.236	0.217	0.500	0.217	○	

● Always stock available ○ Produce according to order

ISO metric threading insert

ISO 965-1980 DIN 13
GB/T 197-2003 Tolerance class: 6g/6H

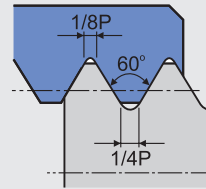

Internal threading

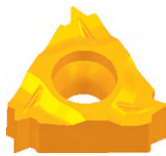

R type

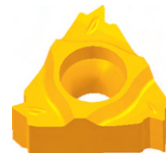
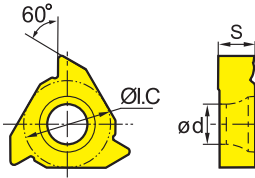

L type

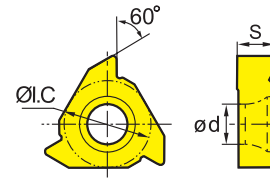

Type		Dimension(inch)				Grade	
		Pitch width (inch)	S	ØI.C	Ød	Coated	Uncoated
Right hand type	Left hand type					YBG201	YD201
RT11.01N-1.00GM	LT11.01N-1.00GM	0.039	0.125	0.250	0.110	○	
RT11.01N-1.25GM	LT11.01N-1.25GM	0.049	0.125	0.250	0.110	○	
RT11.01N-1.50GM	LT11.01N-1.50GM	0.059	0.125	0.250	0.110	○	
RT11.01N-1.75GM	LT11.01N-1.75GM	0.069	0.125	0.250	0.110	○	
RT11.01N-2.00GM	LT11.01N-2.00GM	0.079	0.125	0.250	0.110	○	
RT16.01N-1.00GM	LT16.01N-1.00GM	0.039	0.156	0.375	0.173	○	
RT16.01N-1.25GM	LT16.01N-1.25GM	0.049	0.156	0.375	0.173	○	
RT16.01N-1.50GM	LT16.01N-1.50GM	0.059	0.156	0.375	0.173	○	
RT16.01N-1.75GM	LT16.01N-1.75GM	0.069	0.156	0.375	0.173	○	
RT16.01N-2.00GM	LT16.01N-2.00GM	0.079	0.156	0.375	0.173	○	
RT16.01N-2.50GM	LT16.01N-2.50GM	0.098	0.156	0.375	0.173	○	
RT16.01N-3.00GM	LT16.01N-3.00GM	0.118	0.156	0.375	0.173	○	
RT22.01N-3.50GM	LT22.01N-3.50GM	0.138	0.217	0.500	0.217	○	
RT22.01N-4.00GM	LT22.01N-4.00GM	0.157	0.217	0.500	0.217	○	
RT22.01N-4.50GM	LT22.01N-4.50GM	0.177	0.217	0.500	0.217	○	
RT22.01N-5.00GM	LT22.01N-5.00GM	0.197	0.217	0.500	0.217	○	
RT22.01N-5.50GM	LT22.01N-5.50GM	0.217	0.217	0.500	0.217	○	
RT22.01N-6.00GM	LT22.01N-6.00GM	0.236	0.217	0.500	0.217	○	

● Always stock available ○ Produce according to order



General pitch threading insert without end

External threading

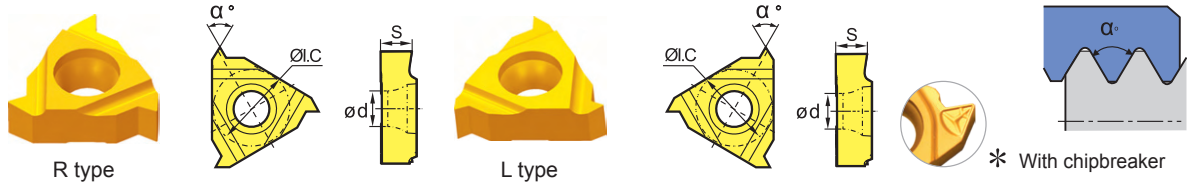

Type			Dimension(inch)				Grade	
							Coated	Uncoated
	Right hand type	Left hand type	Pitch width (teeth/inch)	S	ØI.C	Ød	YBG201	YD201
60°	RT16.01W-A60	LT16.01W-A60	48-16(0.02-0.059)	0.156	0.375	0.173	●	
	RT16.01W-G60	LT16.01W-G60	14-8(0.069-0.118)	0.156	0.375	0.173	●	
	RT16.01W-G60P*	LT16.01W-G60P*	14-8(0.069-0.118)	0.156	0.375	0.173	●	
	RT16.01W-AG60	LT16.01W-AG60	48-8(0.02-0.118)	0.156	0.375	0.173	●	
	RT22.01W-N60	LT22.01W-N60	7-5(0.138-0.197)	0.219	0.500	0.217	●	
55°	RT16.01W-A55	LT16.01W-A55	48-16(0.02-0.059)	0.156	0.375	0.173	●	
	RT16.01W-G55	LT16.01W-G55	14-8(0.069-0.118)	0.156	0.375	0.173	●	
	RT16.01W-G55P*	LT16.01W-G55P*	14-8(0.069-0.118)	0.156	0.375	0.173	●	
	RT16.01W-AG55	LT16.01W-AG55	48-8(0.02-0.118)	0.156	0.375	0.173	●	
	RT22.01W-N55	LT22.01W-N55	7-5(0.138-0.197)	0.219	0.500	0.217	●	

● Always stock available ○ Produce according to order

Internal threading

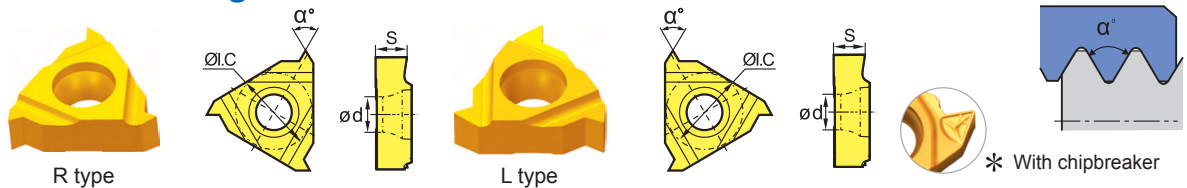

Type			Dimension(inch)				Grade	
							Coated	Uncoated
	Right hand type	Left hand type	Pitch width (teeth/inch)	S	ØI.C	Ød	YBG201	YD201
60°	RT16.01N-A60	LT16.01N-A60	48-16(0.02-0.059)	0.156	0.375	0.173	●	
	RT16.01N-G60	LT16.01N-G60	14-8(0.069-0.118)	0.156	0.375	0.173	●	
	RT16.01N-G60P*	LT16.01N-G60P*	14-8(0.069-0.118)	0.156	0.375	0.173	●	
	RT16.01N-AG60	LT16.01N-AG60	48-8(0.02-0.118)	0.156	0.375	0.173	●	
	RT22.01N-N60	LT22.01N-N60	7-5(0.138-0.197)	0.219	0.500	0.217	●	
55°	RT16.01N-A55	LT16.01N-A55	48-16(0.02-0.059)	0.156	0.375	0.173	●	
	RT16.01N-G55	LT16.01N-G55	14-8(0.069-0.118)	0.156	0.375	0.173	●	
	RT16.01N-G55P*	LT16.01N-G55P*	14-8(0.069-0.118)	0.156	0.375	0.173	●	
	RT16.01N-AG55	LT16.01N-AG55	48-8(0.02-0.118)	0.156	0.375	0.173	●	
	RT22.01N-N55	LT22.01N-N55	7-5(0.138-0.197)	0.219	0.500	0.217	●	

● Always stock available ○ Produce according to order

Whitworth threading insert

ISO 228/1:1982,
DIN 259,B.S.84:1956
Tolerance class: Medium class A

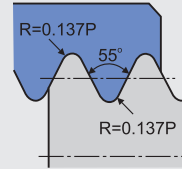

External threading

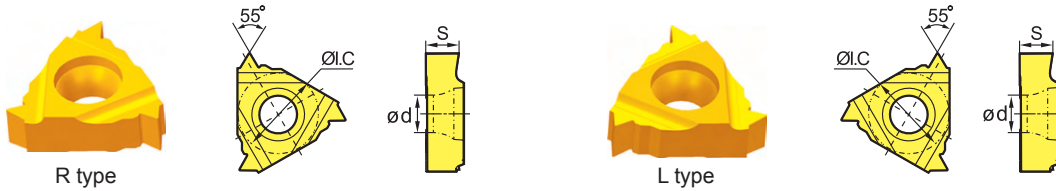

Type		Dimension(inch)				Grade		
Right hand type	Left hand type	Pitch width (teeth/inch)	S	ØI.C	Ød	Coated		Uncoated
RT16.01W-8W	LT16.01W-8W	8	0.156	0.375	0.173	●		
RT16.01W-9W	LT16.01W-9W	9	0.156	0.375	0.173	●		
RT16.01W-10W	LT16.01W-10W	10	0.156	0.375	0.173	●		
RT16.01W-11W	LT16.01W-11W	11	0.156	0.375	0.173	●		
RT16.01W-12W	LT16.01W-12W	12	0.156	0.375	0.173	●		
RT16.01W-14W	LT16.01W-14W	14	0.156	0.375	0.173	●		
RT16.01W-16W	LT16.01W-16W	16	0.156	0.375	0.173	●		

● Always stock available ○ Produce according to order

Internal threading

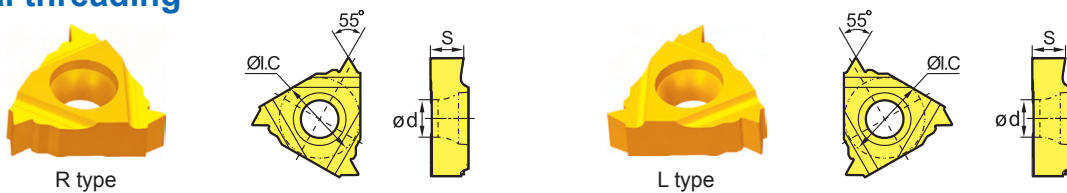

Type		Dimension(inch)				Grade		
Right hand type	Left hand type	Pitch width (teeth/inch)	S	ØI.C	Ød	Coated		Uncoated
RT16.01N-8W	LT16.01N-8W	8	0.156	0.375	0.173	●		
RT16.01N-9W	LT16.01N-9W	9	0.156	0.375	0.173	●		
RT16.01N-10W	LT16.01N-10W	10	0.156	0.375	0.173	●		
RT16.01N-11W	LT16.01N-11W	11	0.156	0.375	0.173	●		
RT16.01N-12W	LT16.01N-12W	12	0.156	0.375	0.173	●		
RT16.01N-14W	LT16.01N-14W	14	0.156	0.375	0.173	●		
RT16.01N-16W	LT16.01N-16W	16	0.156	0.375	0.173	●		

● Always stock available ○ Produce according to order

Unified (UN) threading insert

ASME B1.1-1989
Tolerance class: 2A/2B

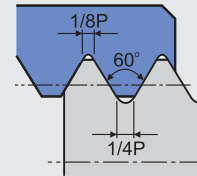

External threading

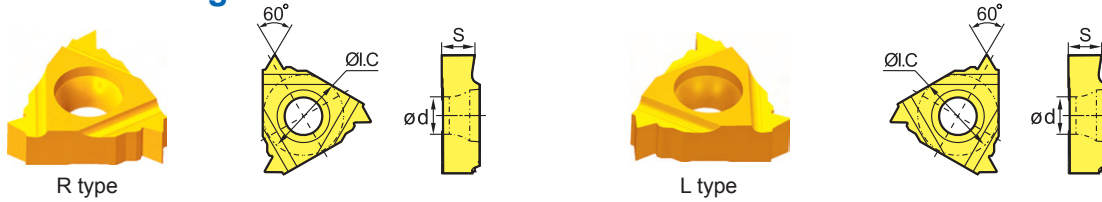

Type		Dimension(inch)				Grade		
Right hand type	Left hand type	Pitch width (teeth/inch)	S	ØI.C	Ød	Coated		Uncoated
RT16.01W-8UN	LT16.01W-8UN	8	0.156	0.375	0.173	●		
RT16.01W-10UN	LT16.01W-10UN	10	0.156	0.375	0.173	●		
RT16.01W-12UN	LT16.01W-12UN	12	0.156	0.375	0.173	●		
RT16.01W-14UN	LT16.01W-14UN	14	0.156	0.375	0.173	●		
RT16.01W-16UN	LT16.01W-16UN	16	0.156	0.375	0.173	●		
RT16.01W-18UN	LT16.01W-18UN	18	0.156	0.375	0.173	●		
RT16.01W-20UN	LT16.01W-20UN	20	0.156	0.375	0.173	●		

● Always stock available ○ Produce according to order

Internal threading

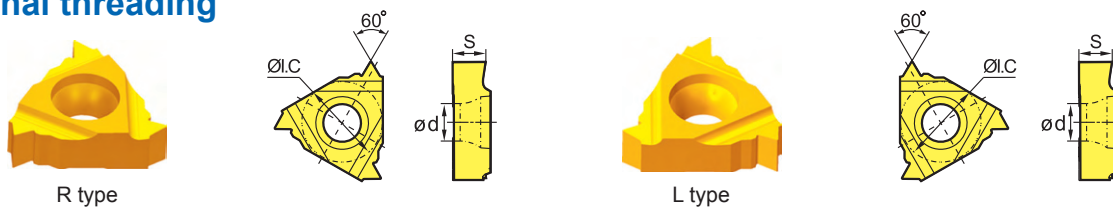

Type		Dimension(inch)				Grade		
Right hand type	Left hand type	Pitch width (teeth/inch)	S	ØI.C	Ød	Coated		Uncoated
RT16.01N-8UN	LT16.01N-8UN	8	0.156	0.375	0.173	●		
RT16.01N-10UN	LT16.01N-10UN	10	0.156	0.375	0.173	●		
RT16.01N-12UN	LT16.01N-12UN	12	0.156	0.375	0.173	●		
RT16.01N-14UN	LT16.01N-14UN	14	0.156	0.375	0.173	●		
RT16.01N-16UN	LT16.01N-16UN	16	0.156	0.375	0.173	●		
RT16.01N-18UN	LT16.01N-18UN	18	0.156	0.375	0.173	●		
RT16.01N-20UN	LT16.01N-20UN	20	0.156	0.375	0.173	●		

● Always stock available ○ Produce according to order

British standard taper pipe threading insert

ISO 7/1:1994
B.S.21:1985
Standard BSPT

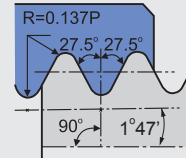

External threading



Type		Dimension(inch)				Grade		
						Coated		Uncoated
Right hand type	Left hand type	Pitch width (teeth/inch)	S	ØI.C	Ød	YBG201	YBM252	YD201
RT16.01W-11 BSPT	LT16.01W-11 BSPT	11	0.156	0.375	0.173	●		
RT16.01W-14 BSPT	LT16.01W-14 BSPT	14	0.156	0.375	0.173	●		
RT16.01W-19 BSPT	LT16.01W-19 BSPT	19	0.156	0.375	0.173	●		
RT16.01W-28 BSPT	LT16.01W-28 BSPT	28	0.156	0.375	0.173	●		

● Always stock available ○ Produce according to order

Internal threading



Type		Dimension(inch)				Grade		
						Coated		Uncoated
Right hand type	Left hand type	Pitch width (teeth/inch)	S	ØI.C	Ød	YBG201	YBM252	YD201
RT16.01N-11 BSPT	LT16.01N-11 BSPT	11	0.156	0.375	0.173	●		
RT16.01N-14 BSPT	LT16.01N-14 BSPT	14	0.156	0.375	0.173	●		
RT16.01N-19 BSPT	LT16.01N-19 BSPT	19	0.156	0.375	0.173	●		
RT16.01N-28 BSPT	LT16.01N-28 BSPT	28	0.156	0.375	0.173	●		

● Always stock available ○ Produce according to order

NPT American standard taper pipe threading insert

ASME B1.20.1-1983
Standard NPT

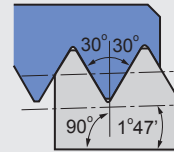

External threading



R type

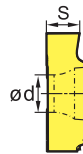
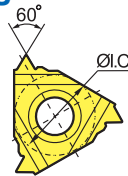

L type

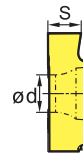
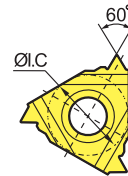

Type		Dimension(inch)				Grade		
Right hand type	Left hand type	Pitch width (teeth/inch)	S	ØI.C	Ød	Coated	Uncoated	
RT16.01W-8 NPT	LT16.01W-8 NPT	8	0.156	0.375	0.173	●		
RT16.01W-11.5 NPT	LT16.01W-11.5 NPT	11.5	0.156	0.375	0.173	●		
RT16.01W-14 NPT	LT16.01W-14 NPT	14	0.156	0.375	0.173	●		
RT16.01W-18 NPT	LT16.01W-18 NPT	18	0.156	0.375	0.173	●		
RT16.01W-27 NPT	LT16.01W-27 NPT	27	0.156	0.375	0.173	●		

● Always stock available ○ Produce according to order

Internal threading



R type

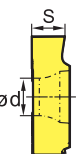
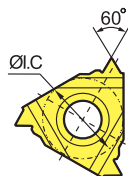

L type

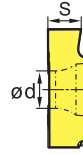
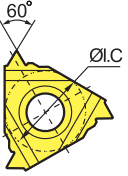

Type		Dimension(inch)				Grade		
Right hand type	Left hand type	Pitch width (teeth/inch)	S	ØI.C	Ød	Coated	Uncoated	
RT16.01N-8 NPT	LT16.01N-8 NPT	8	0.156	0.375	0.173	●		
RT16.01N-11.5 NPT	LT16.01N-11.5 NPT	11.5	0.156	0.375	0.173	●		
RT16.01N-14 NPT	LT16.01N-14 NPT	14	0.156	0.375	0.173	●		
RT16.01N-18 NPT	LT16.01N-18 NPT	18	0.156	0.375	0.173	●		
RT16.01N-27 NPT	LT16.01N-27 NPT	27	0.156	0.375	0.173	●		

● Always stock available ○ Produce according to order

UNJ American standard aerospace and aviation threads

ISO 3161-1999
Tolerance class: 3A

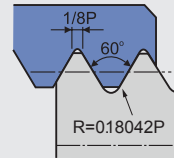

External threading



R type

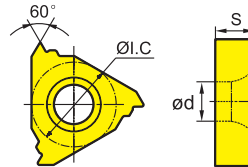

Type	Dimension(inch)				Grade		
	Pitch width (teeth/inch)	S	ØI.C	Ød	Coated		Uncoated
Right hand type					YBG201	YBM252	YD201
RT16.01W-8UNJ	8	0.156	0.375	0.173	●		
RT16.01W-10UNJ	10	0.156	0.375	0.173	●		
RT16.01W-12UNJ	12	0.156	0.375	0.173	●		
RT16.01W-14UNJ	14	0.156	0.375	0.173	●		
RT16.01W-16UNJ	16	0.156	0.375	0.173	●		
RT16.01W-18UNJ	18	0.156	0.375	0.173	●		
RT16.01W-20UNJ	20	0.156	0.375	0.173	●		
RT16.01W-24UNJ	24	0.156	0.375	0.173	●		
RT16.01W-28UNJ	28	0.156	0.375	0.173	●		
RT16.01W-32UNJ	32	0.156	0.375	0.173	●		

● Always stock available ○ Produce according to order



American ACME

ANSI B1.5-1988 ANIS B1.5-1988
Tolerance class: 2G

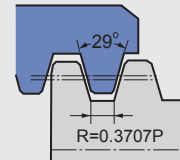

External threading



R type

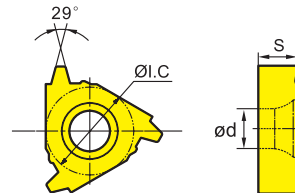

Type	Dimension(inch)				Grade		
	Pitch width (teeth/inch)	S	ØI.C	Ød	Coated		Uncoated
Right hand type					YBG201	YBM252	YD201
RT16.01W-8AC	8	0.156	0.375	0.173	●		
RT16.01W-10AC	10	0.156	0.375	0.173	●		
RT16.01W-12AC	12	0.156	0.375	0.173	●		
RT16.01W-14AC	14	0.156	0.375	0.173	●		
RT16.01W-16AC	16	0.156	0.375	0.173	●		

● Always stock available ○ Produce according to order

Internal threading



R type

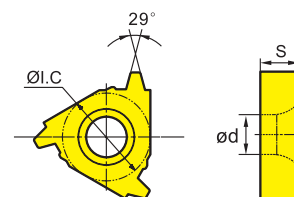

Type	Dimension(inch)				Grade		
	Pitch width (teeth/inch)	S	ØI.C	Ød	Coated		Uncoated
Right hand type					YBG201	YBM252	YD201
RT16.01N-8AC	8	0.156	0.375	0.173	●		
RT16.01N-10AC	10	0.156	0.375	0.173	●		
RT16.01N-12AC	12	0.156	0.375	0.173	●		
RT16.01N-14AC	14	0.156	0.375	0.173	●		
RT16.01N-16AC	16	0.156	0.375	0.173	●		

● Always stock available ○ Produce according to order

American STUB—ACME (short tooth threads)

Defined by: ANSI B1.8-1988
Tolerance class: 2G

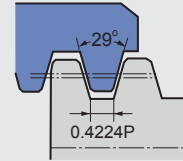

External threading



R type

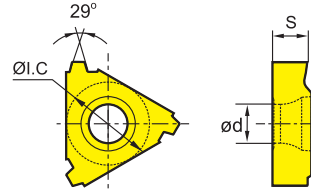

Type	Dimension(inch)				Grade		
	Pitch width (teeth/inch)	S	ØI.C	Ød	Coated		Uncoated
Right hand type					YBG201	YBM252	YD201
RT16.01W-8STAC	8	0.156	0.375	0.173	●		
RT16.01W-10STAC	10	0.156	0.375	0.173	●		
RT16.01W-12STAC	12	0.156	0.375	0.173	●		
RT16.01W-14STAC	14	0.156	0.375	0.173	●		
RT16.01W-16STAC	16	0.156	0.375	0.173	●		

● Always stock available ○ Produce according to order



Internal threading



R type

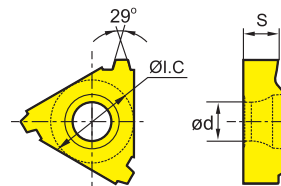

Type	Dimension(inch)				Grade		
	Pitch width (teeth/inch)	S	ØI.C	Ød	Coated		Uncoated
Right hand type					YBG201	YBM252	YD201
RT16.01N-8STAC	8	0.156	0.375	0.173	●		
RT16.01N-10STAC	10	0.156	0.375	0.173	●		
RT16.01N-12STAC	12	0.156	0.375	0.173	●		
RT16.01N-14STAC	14	0.156	0.375	0.173	●		
RT16.01N-16STAC	16	0.156	0.375	0.173	●		

● Always stock available ○ Produce according to order

API 60°

Me=Taper
 2i.p.f—4° 46'
 3i.p.f—7° 01'
 Defined by: API SPEC7:1990
 Tolerance class: API

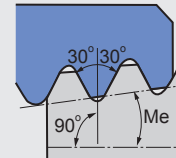

External threading



R type

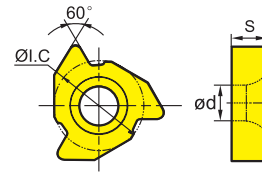

Type	Dimension(inch)				Grade		
	Pitch width (teeth/inch)	S	ØI.C	Ød	Coated		Uncoated
Right hand type					YBG201	YBM252	YD201
RT22.01W-4AP382	4	0.219	0.500	0.217	●		
RT22.01W-4AP383	4	0.219	0.500	0.217	●		
RT22.01W-5AP403	5	0.219	0.500	0.217	●		
RT22.01W-4AP502	4	0.219	0.500	0.217	●		
RT22.01W-4AP503	4	0.219	0.500	0.217	●		

● Always stock available ○ Produce according to order

Internal threading



R type

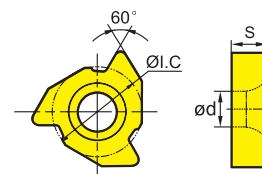

Type	Dimension(inch)				Grade		
	Pitch width (teeth/inch)	S	ØI.C	Ød	Coated		Uncoated
Right hand type					YBG201	YBM252	YD201
RT22.01N-4AP382	4	0.219	0.500	0.217	●		
RT22.01N-4AP383	4	0.219	0.500	0.217	●		
RT22.01N-5AP403	5	0.219	0.500	0.217	●		
RT22.01N-4AP502	4	0.219	0.500	0.217	●		
RT22.01N-4AP503	4	0.219	0.500	0.217	●		

● Always stock available ○ Produce according to order

API Round

Defined by: API spec.5B
Tolerance class: API RD

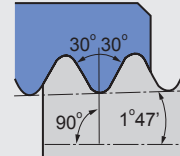

External threading



R type

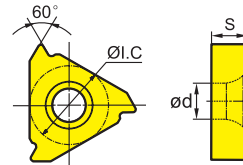

Type	Dimension(inch)				Grade		
	Pitch width (teeth/inch)	S	ØI.C	Ød	Coated		Uncoated
Right hand type					YBG201	YBM252	YD201
RT16.01W-8RD	8	0.156	0.375	0.173	●		
RT16.01W-10RD	10	0.156	0.375	0.173	●		
RT22.01W-8RD	8	0.219	0.500	0.217	●		
RT22.01W-10RD	10	0.219	0.500	0.217	●		

● Always stock available ○ Produce according to order



Internal threading



R type

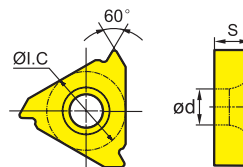

Type	Dimension(inch)				Grade		
	Pitch width (teeth/inch)	S	ØI.C	Ød	Coated		Uncoated
Right hand type					YBG201	YBM252	YD201
RT16.01N-8RD	8	0.156	0.375	0.173	●		
RT16.01N-10RD	10	0.156	0.375	0.173	●		
RT22.01N-8RD	8	0.219	0.500	0.217	●		
RT22.01N-10RD	10	0.219	0.500	0.217	●		

● Always stock available ○ Produce according to order

API Buttress Casing

Me=Taper: 3/4i.p.f-1° 47' suited for dia.4 1/2~13 3/8"
 1i.p.f-2° 23' suited for dia.16"
 Defined by: SEPC.5B.1979
 Tolerance class: API

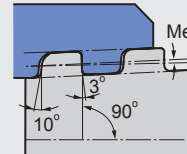

External threading

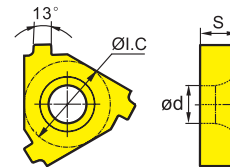

Type	Dimension(inch)				Grade		
	Pitch width (teeth/inch)	S	ØI.C	Ød	Coated		Uncoated
Right hand type					YBG201	YBM252	YD201
RT22.01W-5BUT	5	0.219	0.500	0.217	●		
RT22.01W-5BUT1	5	0.219	0.500	0.217	●		

● Always stock available ○ Produce according to order

Internal threading

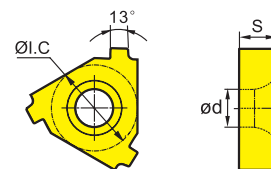

Type	Dimension(inch)				Grade		
	Pitch width (teeth/inch)	S	ØI.C	Ød	Coated		Uncoated
Right hand type					YBG201	YBM252	YD201
RT22.01W-5BUT	5	0.219	0.500	0.217	●		
RT22.01W-5BUT1	5	0.219	0.500	0.217	●		

● Always stock available ○ Produce according to order

ISO metric threading insert (thin type)

ISO 965-1980, DIN 13, GB/T 197-2003
Tolerance class: 6g/6H

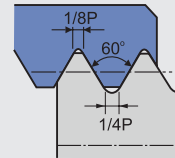

External threading



R type

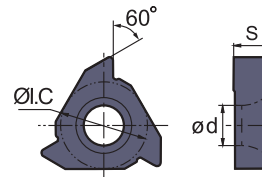

Type	Dimension(inch)				Coated
	Pitch width	S	ØI.C	Ød	
Right hand type					YBG202
RT16.01W-0.5GMB	0.019	0.139	0.375	0.157	●
RT16.01W-0.75GMB	0.030	0.139	0.375	0.157	●
RT16.01W-1.00GMB	0.039	0.139	0.375	0.157	●
RT16.01W-1.25GMB	0.049	0.139	0.375	0.157	●
RT16.01W-1.50GMB	0.059	0.139	0.375	0.157	●
RT16.01W-1.75GMB	0.069	0.139	0.375	0.157	●
RT16.01W-2.00GMB	0.079	0.139	0.375	0.157	●
RT16.01W-2.50GMB	0.098	0.139	0.375	0.157	●
RT16.01W-3.00GMB	0.118	0.139	0.375	0.157	●

● Always stock available ○ Produce according to order

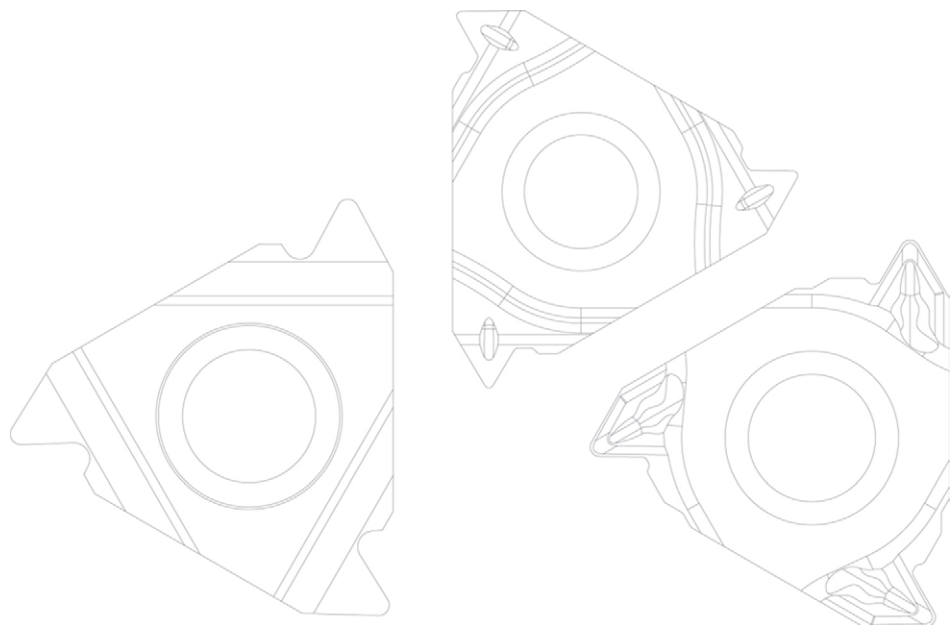

ISO metric threading insert (thin type)

ISO 965-1980, DIN 13, GB/T 197-2003
Tolerance class: 6g/6H

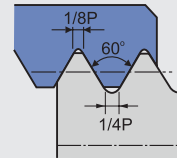

Internal threading

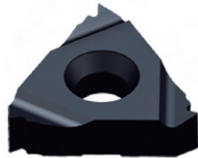

R type

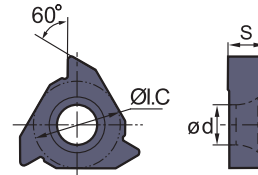

Type	Dimension(inch)				Coated
	Pitch width	S	ØI.C	Ød	
Right hand type					YBG202
RT16.01N-0.5GMB	0.019	0.139	0.375	0.157	●
RT16.01N-0.75GMB	0.030	0.139	0.375	0.157	●
RT16.01N-1.00GMB	0.039	0.139	0.375	0.157	●
RT16.01N-1.25GMB	0.049	0.139	0.375	0.157	●
RT16.01N-1.50GMB	0.059	0.139	0.375	0.157	●
RT16.01N-1.75GMB	0.069	0.139	0.375	0.157	●
RT16.01N-2.00GMB	0.079	0.139	0.375	0.157	●
RT16.01N-2.50GMB	0.098	0.139	0.375	0.157	●
RT16.01N-3.00GMB	0.118	0.139	0.375	0.157	●

● Always stock available ○ Produce according to order

C

General pitch threading insert without end (thin type)

External threading

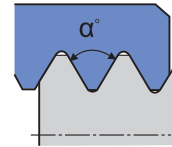
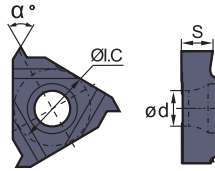
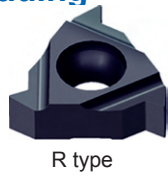

Type		Dimension(inch)					Coated
	Right hand type	Pitch width (teeth/inch)	S	ØI.C	Ød	α°	YBG202
60°	RT16.01W- A60B	0.5 ~1.5(48~16)	0.139	0.375	0.157	60°	●
	RT16.01W- G60B	1.75~3.0(14~8)	0.139	0.375	0.157	60°	●
	RT16.01W- AG60B	0.5 ~3.0(48~8)	0.139	0.375	0.157	60°	●
55°	RT16.01W- A55B	0.5 ~1.5(48~16)	0.139	0.375	0.157	55°	●
	RT16.01W- G55B	1.75~3.0(14~8)	0.139	0.375	0.157	55°	●
	RT16.01W- AG55B	0.5 ~3.0(48~8)	0.139	0.375	0.157	55°	●

● Always stock available ○ Produce according to order



Internal threading

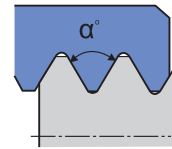
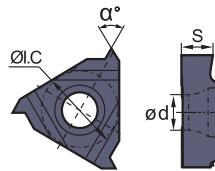
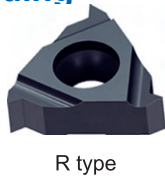

Type		Dimension(inch)					Coated
	Right hand type	Pitch width (teeth/inch)	S	ØI.C	Ød	α°	YBG202
60°	RT16.01N- A60B	0.5 ~1.5(48~16)	0.139	0.375	0.157	60°	●
	RT16.01N- G60B	1.75~3.0(14~8)	0.139	0.375	0.157	60°	●
	RT16.01N- AG60B	0.5 ~3.0(48~8)	0.139	0.375	0.157	60°	●
55°	RT16.01N- A55B	0.5 ~1.5(48~16)	0.139	0.375	0.157	55°	●
	RT16.01N- G55B	1.75~3.0(14~8)	0.139	0.375	0.157	55°	●
	RT16.01N- AG55B	0.5 ~3.0(48~8)	0.139	0.375	0.157	55°	●

● Always stock available ○ Produce according to order

Whitworth threading insert (thin type)

ISO 228/1:1982, DIN 259, B.S.84:1956
Tolerance class: Medium class A

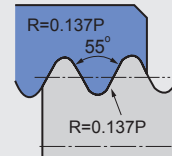

External threading

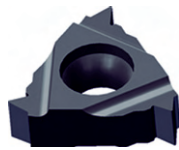

R type

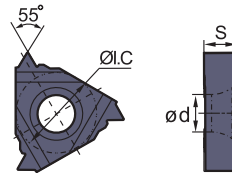

Type	Dimension(inch)				Coated
Right hand type	Pitch width (teeth/inch)	S	ØI.C	Ød	YBG202
RT16.01W-8WB	8	0.139	0.375	0.157	●
RT16.01W-9WB	9	0.139	0.375	0.157	●
RT16.01W-10WB	10	0.139	0.375	0.157	●
RT16.01W-11WB	11	0.139	0.375	0.157	●
RT16.01W-12WB	12	0.139	0.375	0.157	●
RT16.01W-14WB	14	0.139	0.375	0.157	●
RT16.01W-16WB	16	0.139	0.375	0.157	●

● Always stock available ○ Produce according to order

Internal threading

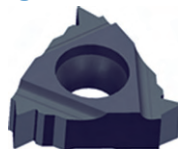

R type

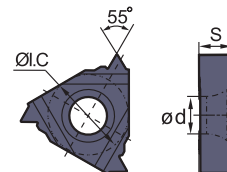

Type	Dimension(inch)				Coated
Right hand type	Pitch width (teeth/inch)	S	ØI.C	Ød	YBG202
RT16.01N-8WB	8	0.139	0.375	0.157	●
RT16.01N-9WB	9	0.139	0.375	0.157	●
RT16.01N-10WB	10	0.139	0.375	0.157	●
RT16.01N-11WB	11	0.139	0.375	0.157	●
RT16.01N-12WB	12	0.139	0.375	0.157	●
RT16.01N-14WB	14	0.139	0.375	0.157	●
RT16.01N-16WB	16	0.139	0.375	0.157	●

● Always stock available ○ Produce according to order

Unified (UN) threading insert (thin type)

ASME B1.1-1989
Tolerance class: 2A/2B

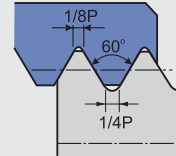

External threading

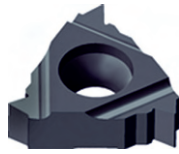

R type

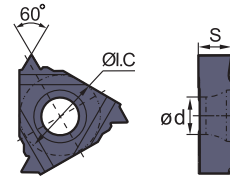

Type	Dimension(inch)				Coated
Right hand type	Pitch width (teeth/inch)	S	ØI.C	Ød	YBG202
RT16.01W-8UNB	8	0.139	0.375	0.157	●
RT16.01W-10UNB	10	0.139	0.375	0.157	●
RT16.01W-12UNB	12	0.139	0.375	0.157	●
RT16.01W-14UNB	14	0.139	0.375	0.157	●
RT16.01W-16UNB	16	0.139	0.375	0.157	●
RT16.01W-18UNB	18	0.139	0.375	0.157	●
RT16.01W-20UNB	20	0.139	0.375	0.157	●

● Always stock available ○ Produce according to order

Internal threading



R type

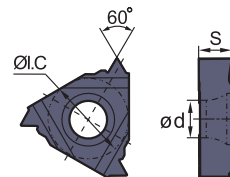

Type	Dimension(inch)				Coated
Right hand type	Pitch width (teeth/inch)	S	ØI.C	Ød	YBG202
RT16.01N-8UNB	8	0.139	0.375	0.157	●
RT16.01N-10UNB	10	0.139	0.375	0.157	●
RT16.01N-12UNB	12	0.139	0.375	0.157	●
RT16.01N-14UNB	14	0.139	0.375	0.157	●
RT16.01N-16UNB	16	0.139	0.375	0.157	●
RT16.01N-18UNB	18	0.139	0.375	0.157	●
RT16.01N-20UNB	20	0.139	0.375	0.157	●
RT16.01N-24UNB	24	0.139	0.375	0.157	●

● Always stock available ○ Produce according to order

British standard taper pipe threading insert (thin type)

ISO 7/1:1994, B.S.21:1985
Standard BSPT

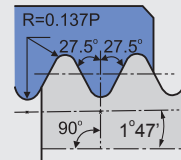

External threading



R type

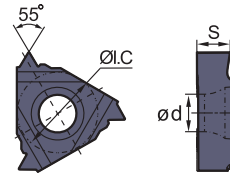

Type	Dimension(inch)				Coated
Right hand type	Pitch width (teeth/inch)	S	ØI.C	Ød	YBG202
RT16.01W-11BSPTB	11	0.139	0.375	0.157	●
RT16.01W-14BSPTB	14	0.139	0.375	0.157	●
RT16.01W-19BSPTB	19	0.139	0.375	0.157	●
RT16.01W-28BSPTB	28	0.139	0.375	0.157	●

● Always stock available ○ Produce according to order

Internal threading

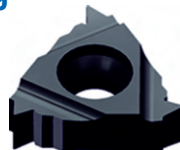

R type

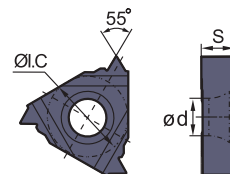

Type	Dimension(inch)				Coated
Right hand type	Pitch width (teeth/inch)	S	ØI.C	Ød	YBG202
RT16.01N-11BSPTB	11	0.139	0.375	0.157	●
RT16.01N-14BSPTB	14	0.139	0.375	0.157	●
RT16.01N-19BSPTB	19	0.139	0.375	0.157	●
RT16.01N-28BSPTB	28	0.139	0.375	0.157	●

● Always stock available ○ Produce according to order

NPT American standard taper pipe threading insert (thin type)

ASME B1.20.1-1983
Standard NPT

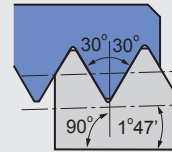

External threading



R type

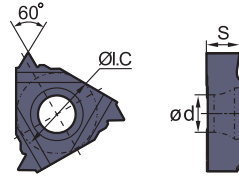

Type	Dimension(inch)				Coated
Right hand type	Pitch width (teeth/inch)	S	ØI.C	Ød	YBG202
RT16.01W-8NPTB	8	0.139	0.375	0.157	●
RT16.01W-11.5NPTB	11.5	0.139	0.375	0.157	●
RT16.01W-14NPTB	14	0.139	0.375	0.157	●
RT16.01W-18NPTB	18	0.139	0.375	0.157	●
RT16.01W-27NPTB	27	0.139	0.375	0.157	●

● Always stock available ○ Produce according to order

Internal threading



R type

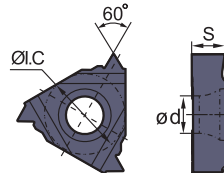

Type	Dimension(inch)				Coated
Right hand type	Pitch width (teeth/inch)	S	ØI.C	Ød	YBG202
RT16.01N-8NPTB	8	0.139	0.375	0.157	●
RT16.01N-11.5NPTB	11.5	0.139	0.375	0.157	●
RT16.01N-14NPTB	14	0.139	0.375	0.157	●
RT16.01N-18NPTB	18	0.139	0.375	0.157	●
RT16.01N-27NPTB	27	0.139	0.375	0.157	●

● Always stock available ○ Produce according to order

Clamping system

Top clamping Screw clamping

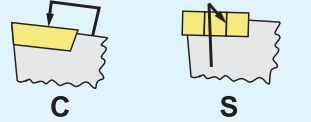

Thread type

N > Internal thread
W > External thread

Cutting direction

Right hand Left hand



S W R 12 C 03 B

Shank height and width

Code	10	12	16	20
Tool body dimension(inch)	0.625×0.625	0.750×0.750	1.000×1.000	1.250×1.250

Tool length

Code	J	A	B	C	D	E	F
Length(inch)	3-1/2	4	4-1/2	5	3	7	8

Cutting edge length

Number of 1/8" of I.C	I.C inch	C	D	R	S	T	V	W
						09		
2	1/4	06	07			11	11	
3	3/8	09	11	09	09	16	16	06
4	1/2	12	15	12	12	22	22	08
5	5/8	16	09	15	15	27		
6	3/4	19		19	19	33		
8	1	25		25	25	44		

Thin type threading tools

Clamping system

Top clamping Screw clamping

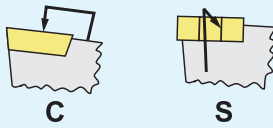

Thread type

- N** > Internal thread
- W** > External thread

Cutting direction

Right hand Left hand



S N R 0750 M 03 B

Shank diameter

Code	0625	0750	1000	1500
Tool body dimension(inch)	0.625	0.750	1.000	1.500

Tool length

Code	H	K	M	Q	R	S	T
Length(inch)	4	5	6	7	8	10	12

Cutting edge length

Number of 1/8" of I.C	I.C inch	C	D	R	S	T	V	W
						09		
2	1/4	06	07			11	11	
3	3/8	09	11	09	09	16	16	06
4	1/2	12	15	12	12	22	22	08
5	5/8	16	09	15	15	27		
6	3/4	19		19	19	33		
8	1	25		25	25	44		

Thin type threading tools

C

External threading tools

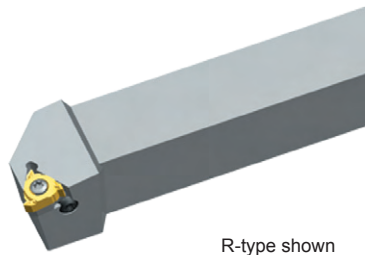

R-type shown

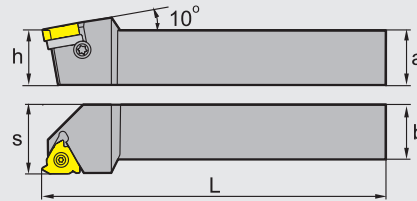

Type	Stock	Basic dimensions(inch)					Applicable inserts	Inserts screw	Shim	Shim screw	Wrench
		a	h	b	L	s					
SWR	▲ 10A03	▲	0.625	0.625	0.625	4	RT16.01W-□□□□	I60M3.5×12	MT16-□□M	SM4×8C	WT15IP WH25L
	▲ 12C03	▲	0.750	0.750	0.750	5					
	▲ 16D03	▲	1.000	1.000	1.000	6					
	▲ 85E03	▲	1.250	1.250	1.000	7					
	▲ 20E03	▲	1.250	1.250	1.250	7	RT22.01W-□□□□	I60M5×17	MT22-□□M	WT20IP WH25L	
	▲ 16D04	▲	1.000	1.000	1.000	6					
	▲ 16E04	▲	1.000	1.000	1.000	7					
	▲ 20E04	▲	1.250	1.250	1.250	7					
SWL	▲ 10A03	▲	0.625	0.625	0.625	4	LT16.01W-□□□□	I60M3.5×12	MT16-□□M	SM4×8C	WT15IP WH25L
	▲ 12C03	▲	0.750	0.750	0.750	5					
	▲ 16D03	▲	1.000	1.000	1.000	6					
	▲ 85E03	▲	1.250	1.250	1.000	7					
	▲ 20E03	▲	1.250	1.250	1.250	7	LT22.01W-□□□□	I60M5×17	MT22-□□M	WT20IP WH25L	
	▲ 16D04	▲	1.000	1.000	1.000	6					
	▲ 16E04	▲	1.000	1.000	1.000	7					
	▲ 20E04	▲	1.250	1.250	1.250	7					

▲ Stock available △ Make-to-order

Internal threading tools

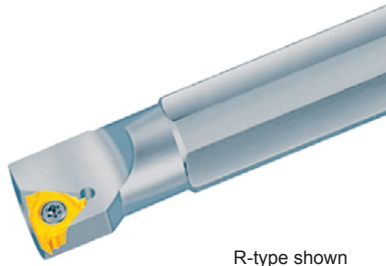

R-type shown

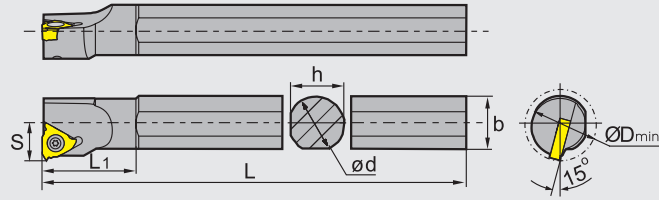

Type	Stock	Basic dimensions(inch)							Applicable inserts	Inserts screw	Shim	Shim screw	Wrench		
		Ød	L	b	ØD _{min}	s	h	L ₁							
SNR	0625K02	▲	0.625	5	0.63	0.50	0.394	0.591	0.823	RT11.01N-□□□□	I60 M2.5X6.5	--	SM4X8C	WT07IP	
	0625M02	▲	0.625	6	0.61	0.63	0.413	0.591	1.020		I60 M3.5X8	WT15IP			
	0625M03	▲	0.625	6	0.61	0.80	0.472	0.591	1.063	RT16.01N-□□□□	I60 M3.5X12	MT16-□□M		WT15IP	
	0750M03	▲	0.75	6	0.748	1.00	0.551	0.709	1.130		WT15IP				
	0750Q03	▲	0.75	7	0.748	1.00	0.551	0.709	1.339		WT15IP				
	1000M03	▲	1.00	6	0.945	1.25	0.669	0.906	1.134		WT15IP				
	1250R03	▲	1.25	8	1.22	1.50	0.866	1.181	1.217		WT15IP				
	1250S03	▲	1.25	10	1.22	1.50	0.866	1.181	1.217		WT20IP				
	1500T03	▲	1.50	12	1.516	2.00	1.063	1.457	1.240		WT15IP				
	2000U03	▲	2.00	14	1.949	2.50	1.378	1.929	1.583		WT20IP				
	0750Q04	▲	0.75	7	0.846	1.00	0.591	0.709	1.378		RT22.01N-□□□□	I60 M5X10		MT22-□□M	WT15IP
	1000R04	▲	1.00	8	0.945	1.25	0.748	0.906	1.535			I60 M5X17		WT20IP	
	1250S04	▲	1.25	10	1.22	1.50	0.866	1.181	1.433	WT15IP					
	1500T04	▲	1.50	12	1.516	2.00	1.063	1.457	1.465	WT20IP					
2000U04	▲	2.00	14	1.909	2.50	1.378	1.85	1.677							
SNL	0625K02	▲	0.625	5	0.63	0.50	0.394	0.591	0.823	LT11.01N-□□□□	I60 M2.5X6.5	--	SM4X8C	WT07IP	
	0625M02	▲	0.625	6	0.61	0.63	0.413	0.591	1.020		I60 M3.5X8	WT15IP			
	0625M03	▲	0.625	6	0.61	0.80	0.472	0.591	1.063	LT16.01N-□□□□	I60 M3.5X12	MT16-□□M		WT15IP	
	0750M03	▲	0.75	6	0.748	1.00	0.551	0.709	1.130		WT15IP				
	0750Q03	▲	0.75	7	0.748	1.00	0.551	0.709	1.339		WT15IP				
	1000M03	▲	1.00	6	0.945	1.25	0.669	0.906	1.134		WT15IP				
	1250R03	▲	1.25	8	1.22	1.50	0.866	1.181	1.217		WH25L				
	1250S03	▲	1.25	10	1.22	1.50	0.866	1.181	1.217		WT20IP				
	1500T03	▲	1.50	12	1.516	2.00	1.063	1.457	1.240		WT15IP				
	2000U03	▲	2.00	14	1.949	2.50	1.378	1.929	1.583		WH25L				
	0750Q04	▲	0.75	7	0.846	1.00	0.591	0.709	1.378		LT22.01N-□□□□	I60 M5X10		MT22-□□M	WT20IP
	1000R04	▲	1.00	8	0.945	1.25	0.748	0.906	1.535			I60 M5X17		WT20IP	
	1250S04	▲	1.25	10	1.22	1.50	0.866	1.181	1.433	WH25L					
	1500T04	▲	1.50	12	1.516	2.00	1.063	1.457	1.465	WT20IP					
2000U04	▲	2.00	14	1.909	2.50	1.378	1.85	1.677							

▲ Stock available △ Make-to-order



External threading tools (For thin type threading)

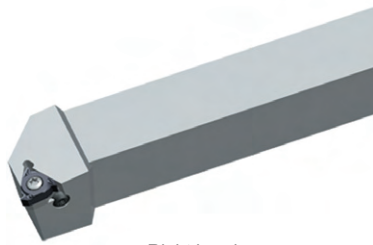

Right hand

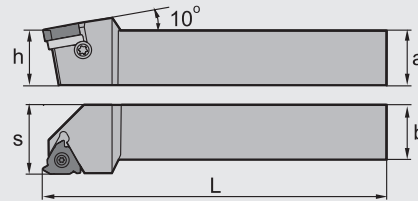

Type	Dimensions(inch)					Applicable inserts	Inserts screw	Shim	Shim screw	Wrench	
	a	h	b	L	s						
SWR	10A03B	0.625	0.625	0.625	4	RT16.01W-□□□□B	I60M3.5x12TT	MT16-□□M	SM4x8C	WT15IP	
	12C03B	0.750	0.750	0.750	5						1.00
	16D03B	1.00	1.00	1.00	6						1.25
	20E03B	1.25	1.25	1.25	7						1.50

Internal threading tools (For thin type threading)

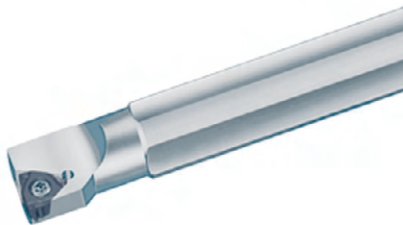

Right hand

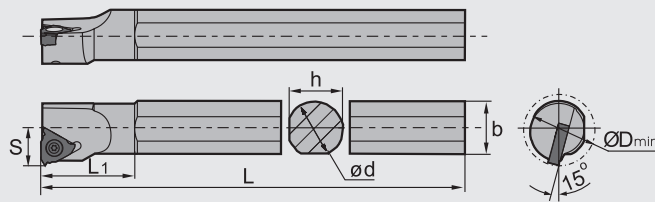

Type	Dimensions(inch)							Applicable inserts	Inserts screw	Shim	Shim screw	Wrench	
	Ød	L	b	ØD _{min}	S	h	L ₁						
SNR	0625M03B	0.625	6.00	0.610	0.75	0.472	0.591	1.063	RT16.01W-□□□□B	I60M3.5x12TT	MT16-□□M	SM4x8C	WT15IP
	0750Q03B	0.75	7.00	0.748	1.00	0.551	0.709	1.339					
	1000M03B	1.00	6.00	0.945	1.25	0.669	0.906	1.134					
	1250R03B	1.25	8.00	1.220	1.50	0.866	1.181	1.217					
	1250S03B	1.25	10.00	1.220	1.50	0.866	1.181	1.217					

● Machining way of threading tools

External threading machining (Right thread)

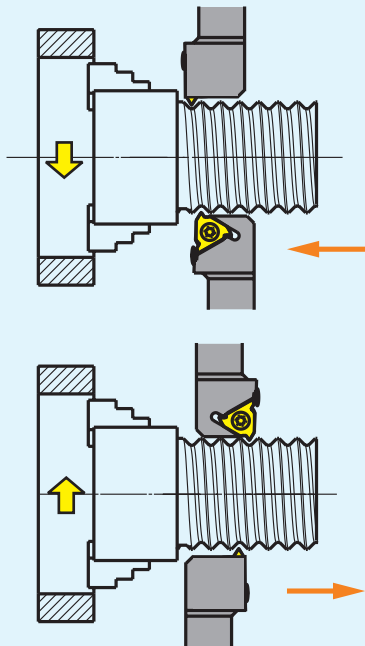

External threading machining (Left thread)

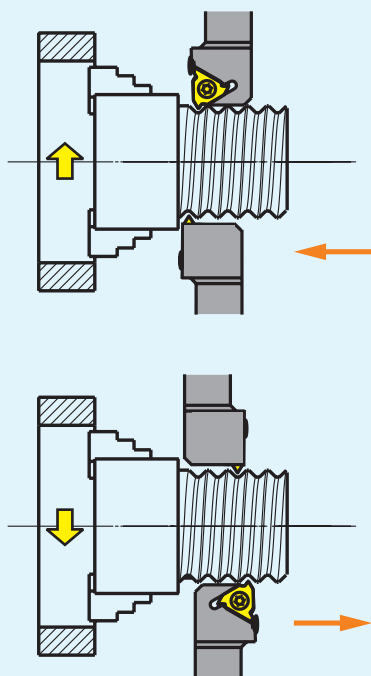

Please follow the following steps to get the best threading result:

- ① Select proper thread machining method.
- ② Decide helical angle, select shim.
- ③ Choose proper insert and toolholder size.
- ④ By checking reference table of standard threading program, select feasible cutting parameters.
- ⑤ Selection feed way.

Internal threading machining (Right thread)

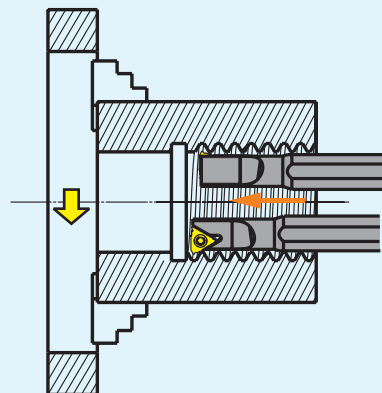

Internal threading machining (Left thread)

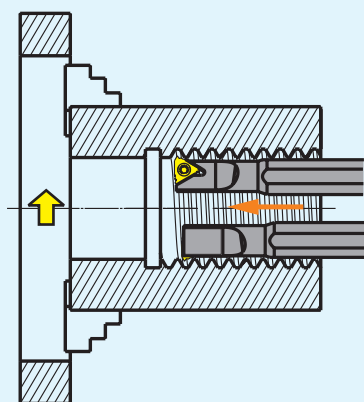

Decide helical angle, select shim

The cutting edge clearance angle affects the dissipation of heat, balance of insert wear, thread pitch quality, and security of the cutting edge. The clearance angle of thread pitch on clearance face is determined by thread helical angle. These two angles are similar to each other. If the inclined angle of the insert is different from the helical angle, then clearance angle won't be the same. The pitch of the helical angle must be the same as the inclined angle of the insert in order to prevent premature wear on the clearance face. The helical angle is calculated as below:

$$\rho = \arctan \frac{P}{d_2 \times \pi}$$

P=Pitch

d₂=pitch diameter

The common inclined angle is 1°, MT standard shim and its inclined angle is 1° too

The calculation of clearance angle:

Clearance angle B is calculated as below:

$$\beta = \arcc(\tan \theta \times \tan \alpha)$$

2θ=Thread profile angle

α=The rake angle of external standard

threading tools is 10°; The rake angle of internal standard threading tools is 15°

The shim has to be changed when helical angle of thread is ≤ clearance angle of the insert, which would cause interference with insert flank. Please change shim to adjust the difference between helical angle of thread and inclined angle of shim to be within 2°~0°.

For Example: when P=1.5, d₂=24mm
Helical Angle 1.14°-(2°~0°)=Inclined Angle
(-0.86°~1.14°)
It's feasible by using standard shim 1°.

Shim specification table are as following:

Screw pitch range	Insert dimensions	Inclined angle	Shim
0.5-3.0	16	0	MT16-00M
		1	MT16-01M
		2	MT16-02M
		3	MT16-03M
3.5-6.0	22	0	MT22-00M
		1	MT22-01M
		2	MT22-02M
		3	MT22-03M

Note: The standard angle of shim for our threading tools is 1° (MT16-01M or MT22-01M)

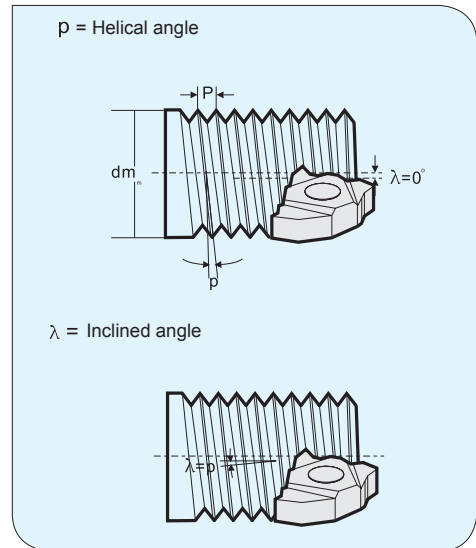

Please refer to table below for actual value:

Thread profile angle 2θ	β	
	External thread	Internal thread
60°	8.5°	6°
55°	7°	7°
30°	4°	2.5°
29°	4°	2.5°

Select shim:

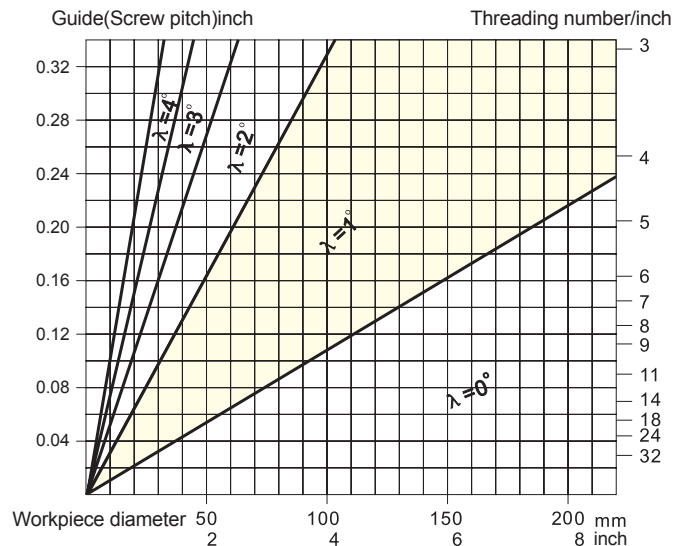

Table of recommended cutting parameters

ISO	Material		Unit cutting force Kc0.4 N/mm ²	Hardness HB	Grade	
					YBG203 YBG205	
					Cutting speed(SFPM)	
P	Carbon steel	C=0.15%	1900	125	500-600	
		C=0.35%	2100	150	450-500	
		C=0.60%	2250	200	400-500	
	Alloy steel	Anneal	2100	180	360-400	
Hardened		2600	275	260-300		
Hardened		2700	300	230-300		
Hardened		2850	350	200-260		
High alloy steel	Anneal	2600	200	300-400		
	Hardened	3900	325	230-300		
Cast steel	Non-alloy	2000	180	600-700		
	low alloy	2500	200	300-400		
	high alloy	2700	225	300-400		
	Martensite steel 12%Mn	3600	250	130-160		
M	Stainless steel	Austenite	2450	180	360-400	
		Martensite/Ferrite	2300	200	400-550	
K	Malleable cast iron	Ferrite	1100	130	360-450	
		Pearlite	1100	230	300-300	
	Gray cast iron	Low tensile-strength	1100	180	360-450	
		High tensile-strength	1500	260	300-350	
Nodular cast iron	Ferrite	1100	160	360-400		
	Pearlite	1800	250	260-300		
N	Al alloy	Non-aging treatment	500	60	4300-4800	
		Aging treatment	800	100	1500-1600	
	Cast aluminum alloy	Non-aging treatment	750	75	1400-1500	
		Aging treatment	900	90	800-1000	
S	Heat resistant alloy	Iron base	Anneal	3000	200	100-150
			Aging	3050	280	90-110
		Ni- or Co- base	Anneal	3500	250	50-80
			Aging	4150	350	30-60
Casting	4150	320	30-50			
H	Hardened steel	Hardened steel	4500	HRC55	130-160	

Note: •The values in the above table are range values. High values in the range could be considered in actual cutting. When trying new cutting speed, please check the cutting edge condition before operation.

•In stainless steel threading, high cutting speed should be used to prevent built-up edge.

•The cutting parameters should be reduced when cutting small pitch thread and when using tools with small nose radius.

•When cutting thread by tools with small nose radius, such as NPT standard thread, it is advisable to use tools with big nose radius first to rough, so as to improve the life of tools with small nose radius.

In-feed way of threading tools

Radial in-feed

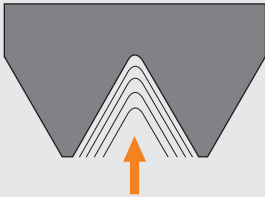

- Easy operating, high general.
- V-shape chip caused by long chip steel workpiece will produce big bend stress on cutting edge.
- It requires low cutting depth, sharp cutting edge and good tough material.
- Big quantity of heat when cutting ,V-shape chip is hard to control.
- Because the interface of cutting chips on the right and left side is long, so it is easy to cause vibration and make the cutting edge suffer more overloading.

Flank in-feed



- Cutting edge suffer small bend stress, stable estate, it is easy for chips formation in deep cutting depth.
- There are enough space to leave chips flow when flank in-feed.
- Big abrasion on right flank.

Modified flank in-feed

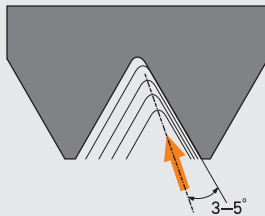

- Right Cutting Edge also engage on cutting depth to a certain extent, it can reduce the abrasion on right side of clearance face.
- Cutting edge suffer small bend stress, stable estate, it is easy for chips formation in deep cutting depth.
- Good Cutting Performance.

Alternate flank in-feed

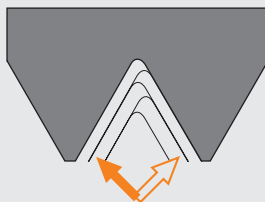

- Cutting edge trade off when machining, equality abrasion on left and right side of clearance face on cutting edge, it can improve the life of tools.
- Chips are flowing from both of right and left side, good chips flowing.
- Recommend using in big screw-pitch thread cutting.



Recommend adopting flank in-feed or alternate flank in-feed under allowable range of machining equipment or programmer, it can eliminate the machining vibration effectively, and it has enough space discharge the chips between pitch. Cutting edge suffer a small stress, machining stable, it likes the general turning process when machining thread, good chip control without extra chips.

Common problems in threading and solutions

Problem	Cause	Solutions
Wear on clearance face	Cutting speed too high.	Reduce cutting speed.
	Low cutting depth, abrasion.	Reduce frequency of feed and friction of cutting edge.
	Inserts are over the center line.	Adopt correct center height.
Asymmetric wear on right and left cutting edge	The inclined angle of insert is different from the helical angle of thread.	Change to proper shim to get correct inclined angle.
	Flank in-feed is not correct.	Change the way of flank in-feed.
Breakage	Cutting speed too low.	Increase cutting speed.
	Cutting force too high.	Increase frequency of feed and reduce Max in-feed.
	Unstable clamping.	Check if workpiece vibrates. Reduce overhang of tool. Verify clamping of workpiece and tool.
	Chip twisting.	Increase the pressure of cooling liquid to blow away chips.
Plastic deformation	High cutting speed, high temperature on cutting area.	Reduce cutting speed. Increase feed frequency and reduce Max cutting depth.
	Insufficient cooling fluid.	Increase cooling fluid supply.
Low thread surface quality	Cutting speed too low. The insert is over the center line. Chips are not under control.	Increase cutting speed. Adjust centre height. Change the operation way of tools to well control chips.
Incorrect profile	Incorrect center height.	Adjust centre height.
	Pitch on machine is not correct.	Adjust machine.
Shallow profile	Cutting speed set wrong.	Adjust cutting depth.
Surface damage	Chips involved or contacted.	Change to flank in-feed to control chip flow direction.
Built-up edge	Temperature of cutting edge is too low. Usually occur when machining stainless steel and low carbon steel.	Increase cutting speed as well as pressure and concentration of cooling fluid. Choose inserts with good toughness.
Crack on surface	Cutting force too high	Reduce the cutting depth of each feed.
Vibration	Incorrect clamping of workpiece or tool	Verify clamping of workpiece and tool. Minimize overhang of tool.
	Incorrect cutting parameters	Increase cutting speed or reduce it substantially.
	Incorrect tool clamping	Adjust center height.